

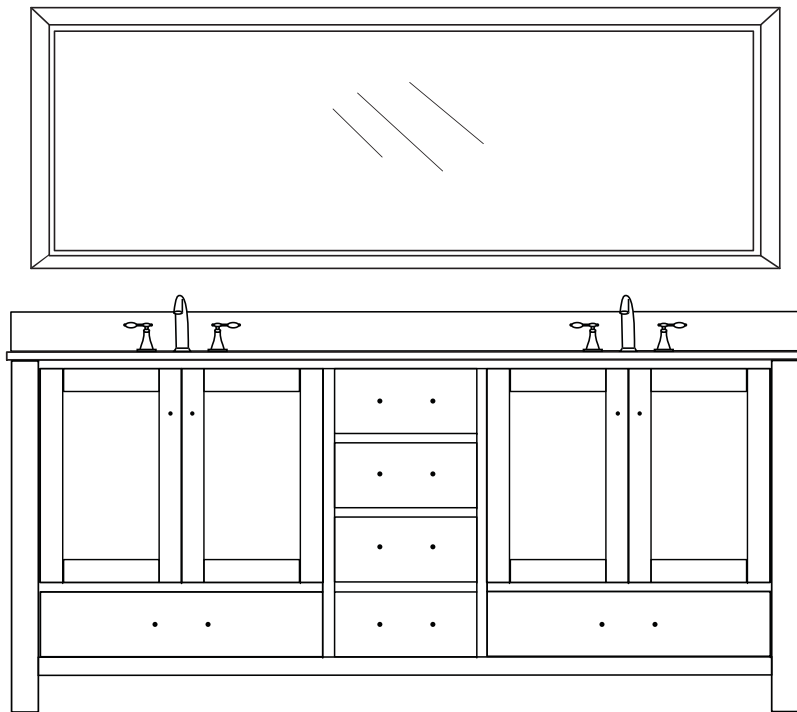

INSTALLATION GUIDE

FOR CO-10172D





FOR MODELS:

- CO-10172D-WMCG
- CO-10172D-WMES
- CO-10172D-WMTP
- CO-10172D-WMWH
- CO-10172D-WMCG-NM
- CO-10172D-WMES-NM
- CO-10172D-WMTP-NM
- CO-10172D-WMWH-NM
- CO-10172D-CAB-CG
- CO-10172D-CAB-ES
- CO-10172D-CAB-TP
- CO-10172D-CAB-WH

INSTALLATION MANUAL

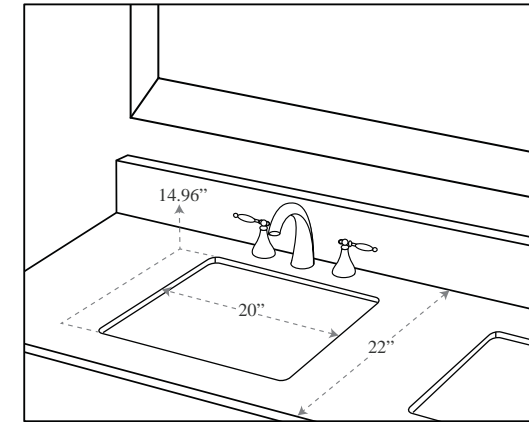
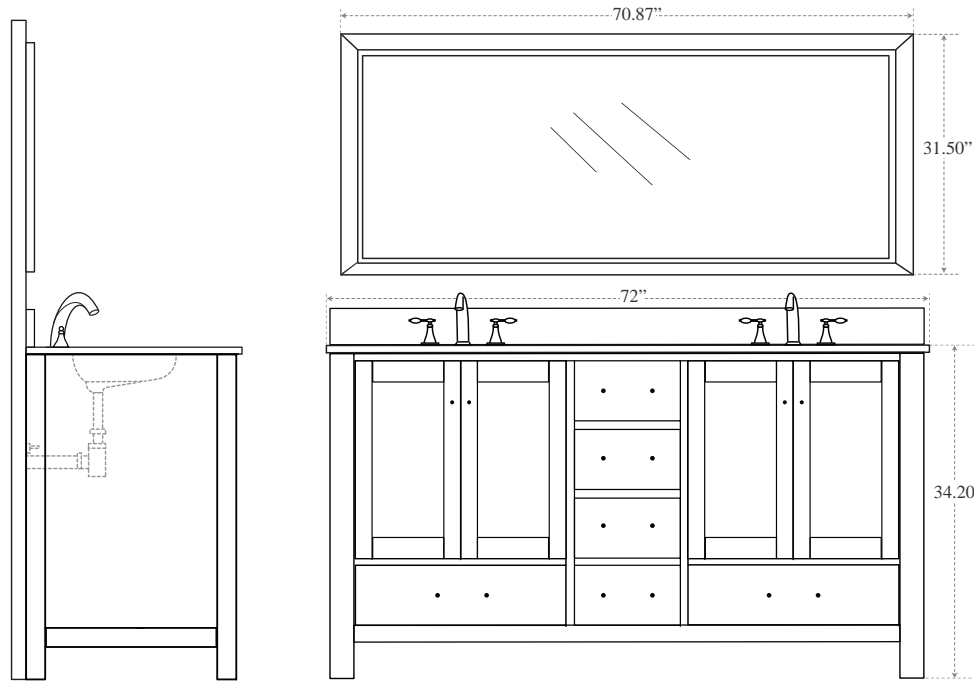

PACKING LIST (Not all components may be included, depending upon your purchase)

SAFETY & PRECAUTIONS

1. Exclusive Heritage recommends you to review the Installation Manual before starting the vanity installation.
2. Please handle heavy objects with care and support to avoid mishaps damages or injuries.
3. After completing the installation, please wait up to 24-hours before using the vanity.

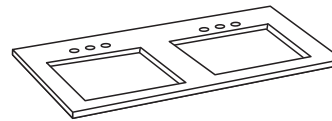
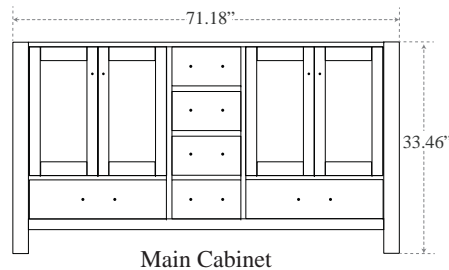

Optional: Countertop

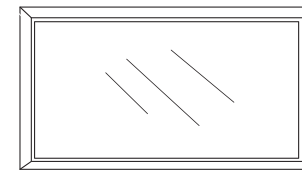

Optional: Mirror

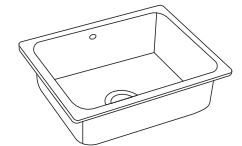

Optional: Square Sink

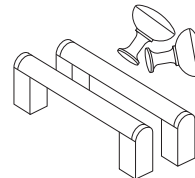

Cabinet Hardware

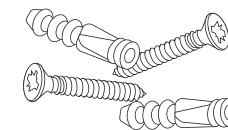

Mirror Installation Screws

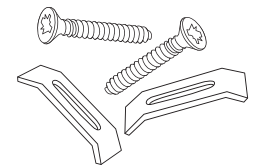

Sink Mounting Kit

RECOMMENDED TOOLS

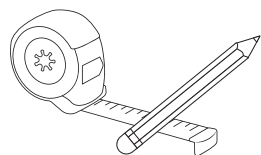

Pen & Ruler

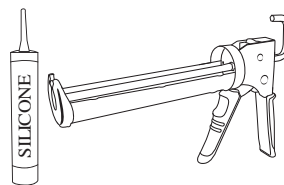

Caulk & Caulk Gun

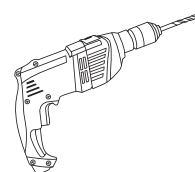

Power Drill

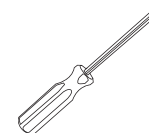

Phillips Screwdriver

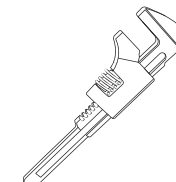

Adjustable Wrench



Goggles, Gloves & Ear Plugs

4. When cleaning the top or cabinet use mild strength for scrubbing to avoid scratching the surface.
5. Professional installation recommended.

OPTIONAL: HINGES INSTALL & ADJUSTMENT

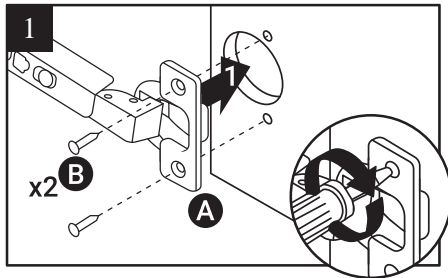

1. Attach hinge (A) to door with screws (B).

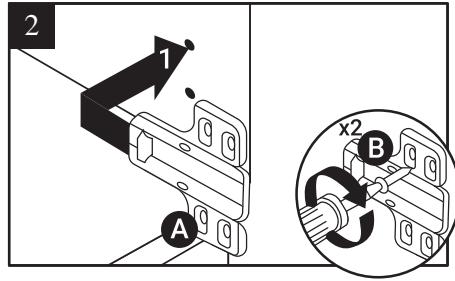

2. Attach mounting plate (A) to cabinet with screw (B).

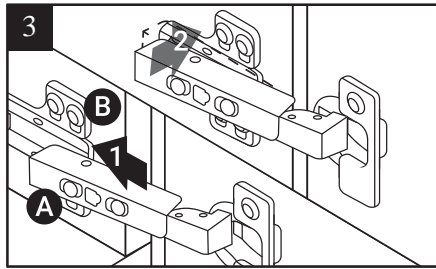

3. Attach hinge (A) to mounting plate (B) and snap into position.

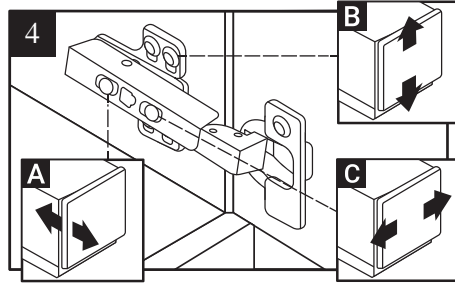

4. Align door to cabinet. Use screw (A) to adjust door depth, screw (B) to adjust vertically and screw (C) to adjust horizontally.

OPTIONAL: SINK INSTALLATION

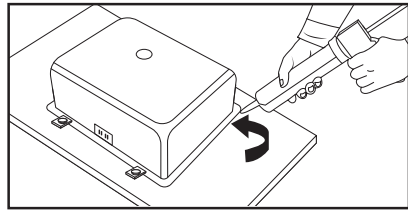

- Apply a continuous stream of silicone glue around the sink top rim. Flip the countertop upside down.
- Carefully align the sink onto countertop back, fasten the sink rim with the sink mounting screws.
- Apply a continuous silicone glue along the sink edges to seal any gaps.

OPTIONAL: MIRROR INSTALLATION

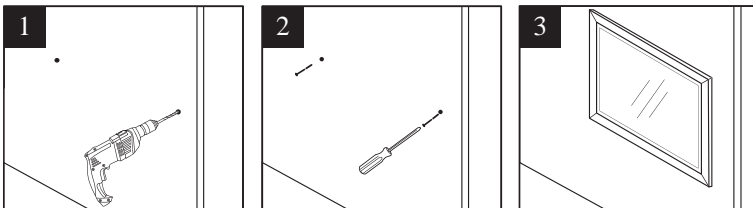

1. Measure the screw holes from the backside of mirror (Fig. A) distance. Then drill the holes into the wall.

2. Insert the anchor screws into the holes and drill the screws into them.

3. Hang up the mirror into position and it's done.

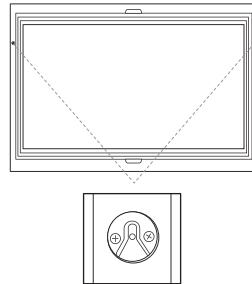
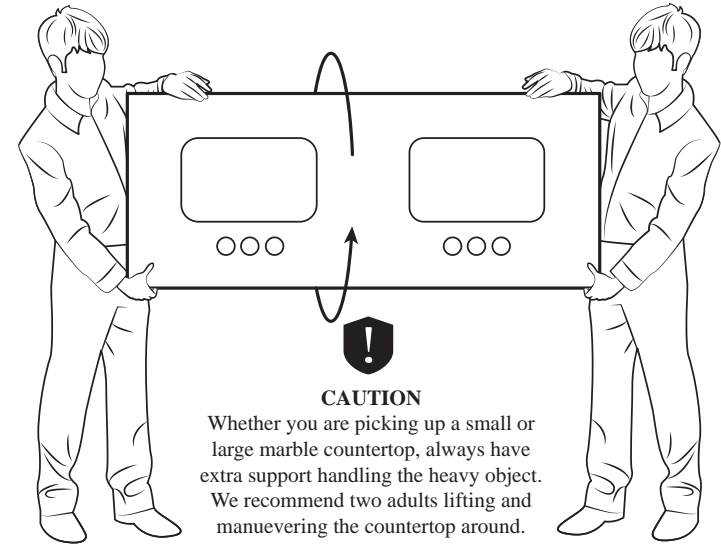

Fig. A

HOW TO CARRY THE TOP



CAUTION
Whether you are picking up a small or large marble countertop, always have extra support handling the heavy object. We recommend two adults lifting and maneuvering the countertop around.

OPTIONAL: TOP & BACKSPLASH INSTALLATION

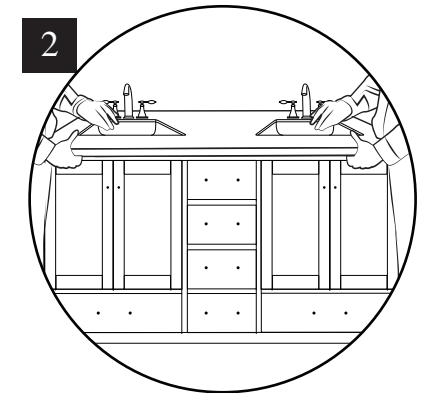
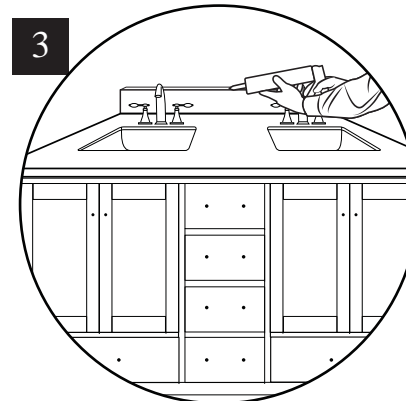
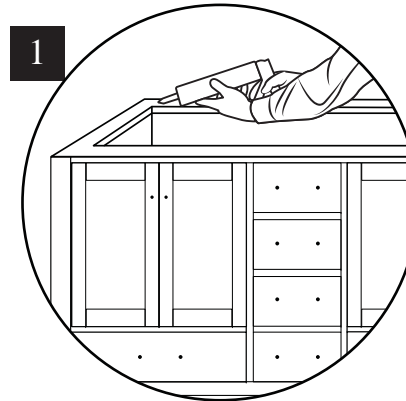

1. Apply a continuous stream of silicone glue around the top of the cabinet.

2. Carry the countertop and gently place it onto the cabinet.

3. Install the backsplash by applying silicone glue near the edge of the countertop. Then place the backsplash onto the silicone area. Add additional silicone onto the edges for sealant if necessary.

Note: Allow up to 24-hours for the silicone glue to dry before using the vanity.



LIMITED WARRANTY

The Exclusive Heritage bathroom vanities you (herein also defined as the Original Buyer/End-User) have purchased from one of its authorized distributors is covered under the 2 Years Limited Warranty policy. The warranty protects your purchase against material defects. In the event a new vanity replacement is warranted, Exclusive Heritage reserved the right to perform a complete and thorough investigation, including but not limited to material defects and causes. If one of the defective causes which falls within the list identified below, the warranty will be voided. In the event an exact replacement is not available, Exclusive Heritage reserved the right to replace the product with a similar model but comparable in value. **THIS WARRANTY IS NOT TRANSFERABLE.**

VOID OF WARRANTY IF

- The product was purchased from an unauthorized seller.
- The contractor, service installer, or yourself failed to follow installation procedures.
- The installation was performed not in accordance with local electrical, plumbing, and structural codes.
- The product was not cared for per proper maintenance guidelines.
- The product sustained damage as a result of excessive and aggressive use of abrasive chemicals/cleaners.
- The product was subjected to abusive treatment such as placing, dropping, rubbing, or hammering against heavy objects.
- Unauthorized modifications were made to the product.
- Accidental occurrences as a result of fire, earthquake, flood, natural disaster, or acts of God.

Exclusive Heritage would like to inform you, as the Original Buyer/End-User who files for a new replacement request, that certain aspects of this warranty does not cover the followings:

- Transportation or shipping cost
- Labor cost
- Travel time
- Lost wages or profits
- Home damages
- Professional service fees (attorney, experts, etc.)
- Investigation, analyses, report costs
- Other Contingent Liabilities

This warranty gives you specific legal rights, some States do not allow limitations on how long an implied warranty lasts. So the above limitation may not apply to you and you may also have other rights which vary from state to state.

TO OBTAIN SERVICE UNDER WARRANTY

Send E-mail To: warranty@ehhomeusa.com

Subject: Customer Support - Warranty

Please include the following information:

- A. Date of purchase and installation
- B. Proof of Purchase (copy of original dated invoice)
- C. Description of nature of defect
- D. Model number

LEGAL DISCLAIMER

Exclusive Heritage LLC provides all product information and data in a “AS IS”, “WHERE IS”, and “WHERE AVAILABLE” format. The product prices and specifications are subject to changes without notice. Exclusive Heritage is not responsible for, nor have any liability for mistakes or typographical errors, including liability of incidental, consequential, and special damages. You agree to indemnify, defend, and hold harmless with Exclusive Heritage LLC, its affiliates, agents, managers, employees, and licensors from and against any and all claims and expenses, including reasonable attorneys’ fees, arising out of or related in any way to your use of the website, product manual, installation guide, care and maintenance guide, violation of this Agreement, violation any law or regulation, or violation of any third party proprietary or privacy right.